



AVCOMM®

# 8010GX2

## Datasheet

Aiming to create better and safer working environments and life experiences through the products we deliver.



AVCOMM Technologies, Inc

[www.avcomm.us](http://www.avcomm.us)

Email: [info@avcomm.us](mailto:info@avcomm.us)

Phone: (713) 933-4534

Address: 333 West Loop North, Suite 460  
Houston, TX 77024  
United States

## Rugged High Performance L2+ Cyber Security Switch

# 8010GX2

### Industrial 10-port Full Gigabit Managed Ethernet Switch, 8GT+2GSFP

8010GX2 is designed for industrial environments requiring high security and high quality Ethernet/Fiber communication, such as industrial automation, road traffic control, etc. 8010GX2 provides 10-port full-gigabit Ethernet including 8-port Gigabit RJ45 and 2-port 100M/1G SFP. 8010GX2 provides wire-speed switching, Cyber Security, network redundancy...L2+ management software features. Full Gigabit capability and rugged industrial design ensures system high performance and reliability in harsh environments. For convenient traffic control and zero packet loss data transmission, the switch offers contemporary management and security functions.



### High performance CPU & Full Gigabit Switching

- Powerful 1.2GHz ARM Cortex-A9 processor
- Non-blocking switch fabric design
- 10-port Full Gigabit Ethernet ports, including 8 Gigabit RJ45 and 2 100/1000M SFP
- 8 flexible Class of Service(CoS) queues
- 16K MAC address table
- 9Kb Jumbo Frame
- Fiber ports support both 100M and 1000M SFP
- DDM function for fiber connectivity monitoring
- Energy-Efficient Ethernet for power saving

### IEC62443-4-2 Level 3 / 4 Cyber Security

- 802.1X/RADIUS port-based access control
- IP Security/Port Security
- HTTPs/SSH Management IP secure access
- Supports advanced cyber security features, 802.1X MAB, TACAS+, DHCP Snooping, IP Source Guard, Dynamic ARP Inspection, advanced Port Security & L2-L7 Access Control List

### ITU ERPSv2 PLUS Ring Technology

- ITU G.8032 v1/v2 ERPS Ring Redundancy & HW-based CFM for quick acknowledgement while GbE copper link failure, providing 20ms recovery time and seamless restoration.
- ERPSv2 available to replace legacy Ring + Chain + Dual Homing
- Inter-Operability with 3rd party industrial switch and still remain fast recovery time.
- Support Enhanced RSTP for large ring network topology with up to 80 switches

### L2+ Management Switch Features

- Various configuration paths, including WebGUI, CLI, SNMP, Modbus TCP, LLDP topology control
- Layer 2 Switch features include VLAN, QoS, LACP/Trunk, Rapid Spanning Tree protocol...etc
- IGMP Snooping v1/v2/v3, IGMP Query, 512 L2 Multicast Groups for video applications
- Built-in DHCP Server that automatically provides and assigns IP addresses, default gateways to clients

### Industrial IoT LAN & Cloud Management

- Support Software Utilities:
  - ANMS Network Management System
  - AIAS for Configuration Management
- Support Modbus TCP for monitoring in field

### Rugged Design for Wayside Network Switching with Wide Power Input Range

- 12~48V wide power range design with redundant power input
- Excellent heat dissipation design for operating in -40~75°C environments
- High level **EMC protection** exceeding traffic control and heavy industrial standards' requirements
- IEC 61000-6-2/4 Heavy Industrial Environment
- EN50121-4 railway trackside EMC compliance

✓ **ITU-T G.8032 ERPSv2 gives ultimate Inter-Operability, Flexibility, and Scalability**

G.8032 v.2 ERPS is becoming the most common standard for redundancy on industrial networks and replacing proprietary ring redundancy and standard Ethernet Ring Switching, as it provides stable protection of the entire Ethernet Ring from any loops and open standard for 3<sup>rd</sup> party devices. The ITU-T G.8032 v2 ERPS recovers the network break within less than 20ms recovery time thus significantly increases network reliability for critical IIoT applications, such as heavy industrial automation (power substation and oil and gas vertical markets), ITS (traffic control, public transportation), railway networks, and other smart city applications concerning public safety.

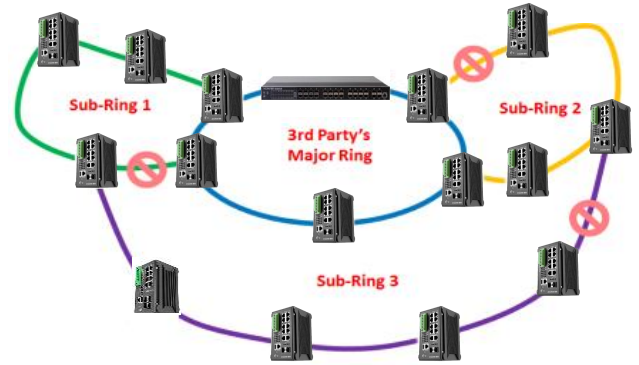

G.8032 v1 only supports single ring topology, whilst G.8032 version 2 additionally features recovery switching for Ethernet traffic in Multiple Ring (ladder) of conjoined Ethernet Rings by one or more interconnections which saves deployment costs by providing wide-area multipoint connectivity with reduced number of links. Deploying switches with support of G.8032 v2 ERPS ensures highly resilient Ethernet infrastructure whilst simultaneously saving costs, as they can interoperate with third-party switches and still guarantee fast network recovery time without any data loss.

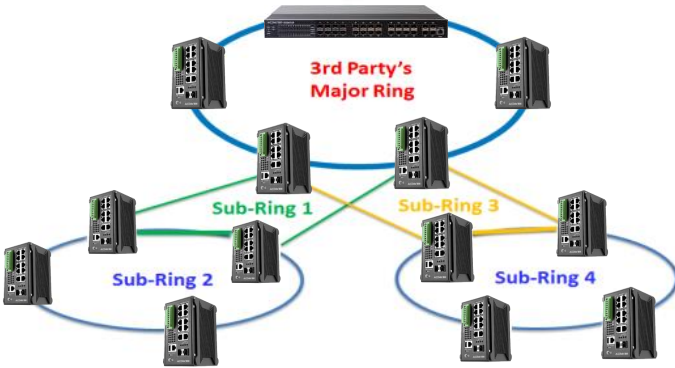

✓ **ITU ERPS v2 PLUS Technology – Fast Giga Copper Recovery Time**

The adaption of Broadcom® CFM Technology can reduce CFM Transmission for link failure within 3.3ms, thus to detect the ring link fault within 11.55ms (3.5 times the CFM Interval) for ERPSv2 mechanism to respond. Once the ring port fails, the ERPS RPL-Owner will forward the backup port and recover the GbE copper within 20ms under the condition that 250pcs nodes in one ring.

✓ **ITU-T G.8032 ERPSv2 reduces coupling Ring failure recovery time**

The G.8032 ERPS v2 technology effectively saves the recovery time for coupling ring link breakdown from 300 sec to less than 20ms by immediately change the topology of both major ring and sub ring.

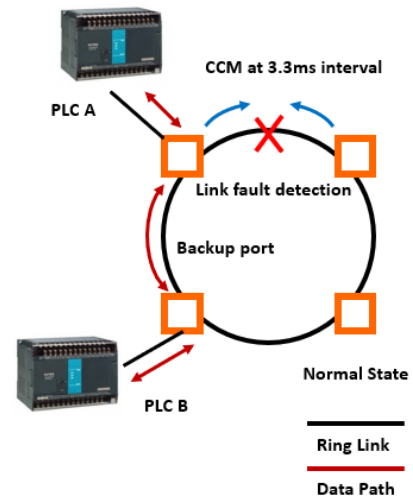
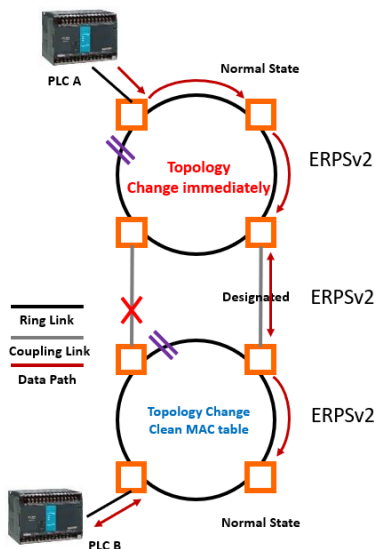

MAB enables port-based access control by bypassing the MAC address authentication process to TACACS+/Radius Server. Prior to MAB, the endpoint's (ex. PLC) identity is unknown and all traffic is blocked. The switch examines a single packet to learn and authenticate the source MAC address. After MAB succeeds, the endpoint's identity is known and all traffic from that endpoint is allowed. The switch performs source MAC address filtering to help ensure that only the MAB-authenticated endpoint is allowed to send traffic.

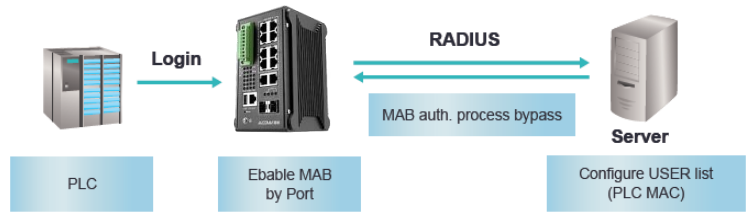

In addition to MAB, the authentication can also be done by the pre-configured static or auto-learn MAC address table in the switch.

- MAC address Auto Learning enables the switch to be programmed to learn (and to authorize) a preconfigured number of the first source MAC addresses encountered on a secure port. This enables the capture of the appropriate secure addresses when first configuring MAC address-based authorization on a port. Those MAC addresses are automatically inserted into the Static MAC Address Table and remained there until explicitly removed by the user.
- The port security is further enhanced by Sticky MAC setting. If Sticky MAC address is activated, the MACs/Devices authorized on the port 'sticks' to the port and the switch will not allow them to move to a different port.
- Port Shutdown Time allows users to specify for the time period to auto shutdown the port if a security violation event occurs.

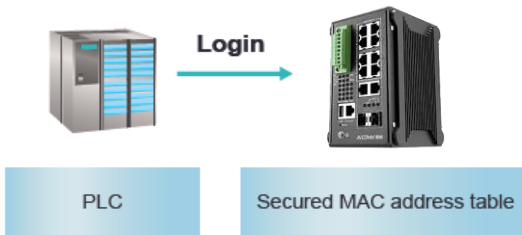

## ✓ DHCP Snooping

DHCP snooping acts like a firewall between untrusted hosts and trusted DHCP servers. It performs the following activities:

- Validates DHCP messages received from untrusted sources and filters out invalid messages.
- Rate-limits DHCP traffic from trusted and untrusted sources.
- Builds and maintains the DHCP snooping binding database, which contains information about untrusted hosts with leased IP addresses.
- Utilizes the DHCP snooping binding database to validate subsequent requests from untrusted hosts.

DHCP snooping is enabled on a per-VLAN basis. By default, the feature is inactive on all VLANs. You can enable the feature on a single VLAN or a range of VLANs.

## ✓ Dynamic ARP Inspection (DAI)

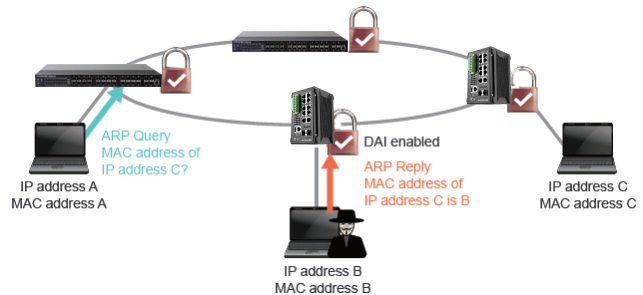

DAI validates the ARP packets in a network. DAI intercepts, logs, and discards ARP packets with invalid IP-to-MAC address bindings. This capability protects the network from some man-in-the-middle attacks.

DAI ensures that only valid ARP requests and responses are relayed. The switch performs these activities:

- Intercepts all ARP requests and responses on untrusted ports
- Verifies that each of these intercepted packets has a valid IP-to-MAC address binding before updating the local ARP cache or before forwarding the packet to the appropriate destination
- Drops invalid ARP packets.

DAI determines the validity of an ARP packet based on valid IP-to-MAC address bindings stored in a trusted database, the DHCP snooping binding database. This database is built by DHCP snooping if DHCP snooping is enabled on the VLANs and on the switch. If the ARP packet is received on a trusted interface, the switch forwards the packet without any checks. On untrusted interfaces, the switch forwards the packet only if it is valid.

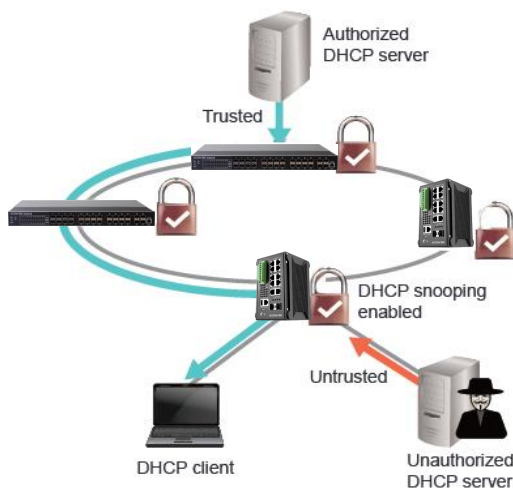

IP source guard provides source IP address filtering on a Layer 2 port to prevent a malicious host from impersonating a legitimate host by assuming the legitimate host's IP address. The feature uses dynamic DHCP snooping and static IP source binding to match IP addresses to hosts on untrusted Layer 2 access ports.

Initially, all IP traffic on the protected port is blocked except for DHCP packets. After a client receives an IP address from the DHCP server, or after static IP source binding is configured by the administrator, all traffic with that IP source address is permitted from that client.

Traffic from other hosts is denied. This filtering limits a host's ability to attack the network by claiming a neighbor host's IP address.

### ✓ IPv4/v6 Access Control List (ACL)

Packet filtering limits network traffic and restricts network use by certain users or devices. ACLs filter traffic as it passes through a switch and permits or denies packets crossing specified interfaces. An ACL is a sequential collection of permit and deny conditions that apply to packets. When a packet is received on an interface, the switch compares the fields in the packet against any applied ACLs to verify that the packet has the required permissions to be forwarded, based on the criteria specified in the access lists.

The Switch supports L2-L7 ACLs, parsing up to 128 bytes/packet and L2-L7 packet classification and filtering IPv4/IPv6 traffic, including TCP, User Datagram Protocol (UDP), Internet Group Management Protocol (IGMP), and Internet Control Message Protocol (ICMP).

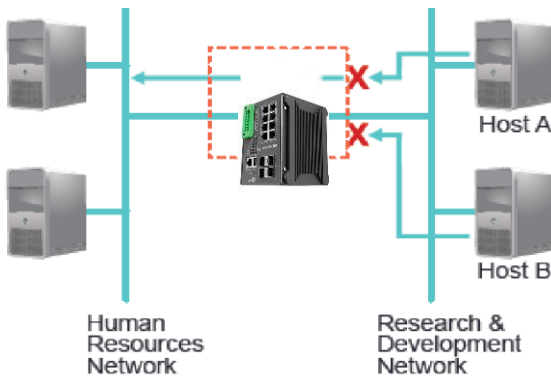

**X** = ACL denying traffic from Host B and permitting traffic from Host A  
**←** = Packet

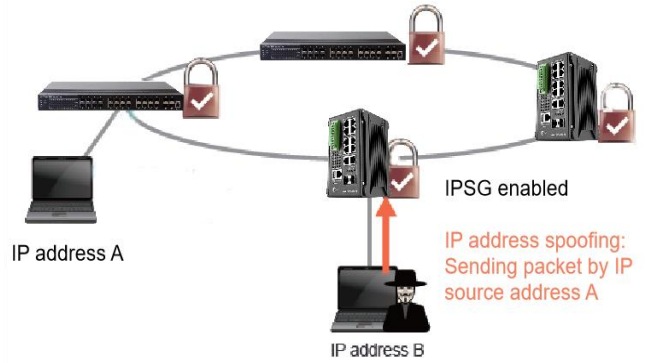

### ✓ NMS ANMS Made Easy Deploy and Visualize Large Scale of ERPS Ring and VLAN

It is very time consuming and technical to set up a large group of ERPS v2 ring. However, ANMS NMS provides a smart way to configure a group of ERPS ring and visualize ERPS major/sub ring in purple/yellow color. With VLAN visualization, devices, ports, and links with the VLAN ID will be colored-coded.

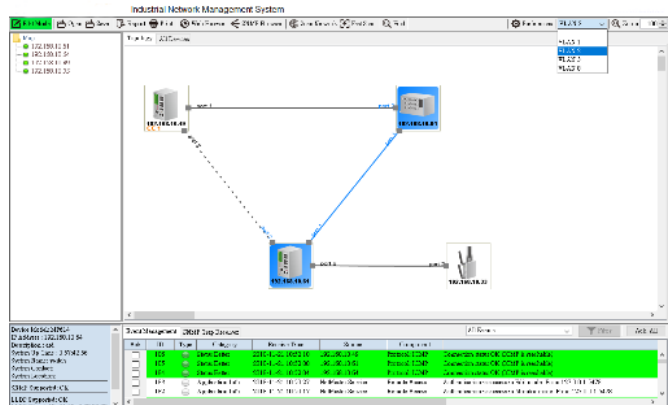
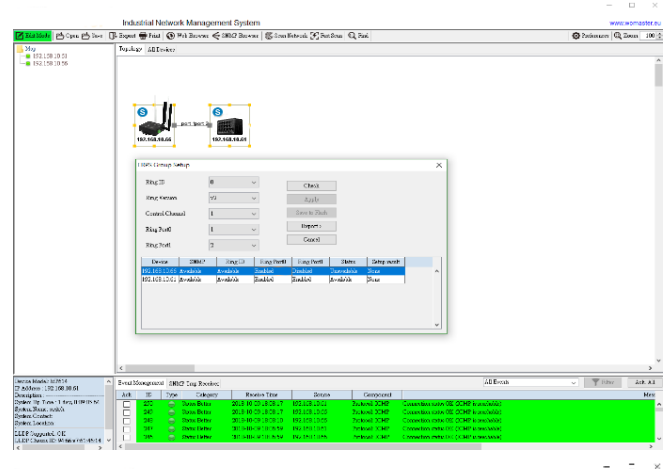

### ✓ Multi-Level User Passwords

Different centralized authentication server is supported such as RADIUS and TACACS+. Using a central authentication server simplifies account administration, in particular when you have more than one switches in the network.

Authentication Chain is also supported. An authentication chain is an ordered list of authentication methods to handle more advanced authentication scenarios. For example, you can create an authentication chain which first contacts a RADIUS server, and then looks in a local database if the RADIUS server does not respond.





## Ordering Information

Model Name	Description
8010GX2	10-Port Fully Managed Industrial Ethernet Switch, 8 RJ45 Ports 10/100/1000Base-T(X), 2 SFP Slots 1000BaseSFP+, DIN-Rail, Dual Power Input 12-48VDC, -40°C-75°C
8010GX2-PS	8010GX2, w/ 1 APS-30-24
8010GX2-2SX	8010GX2, w/ 2 AVC-SFP-SX
8010GX2-2SX-PS	8010GX2, w/ 1 APS-30-24 and 2 AVC-SFP-SX
8010GX2-2LX-10	8010GX2, w/ 2 AVC-SFP-LX-10
8010GX2-2LX-10-PS	8010GX2, w/ 1 APS-30-24 and 2 AVC-SFP-LX-10
8010GX2-2LX-40	8010GX2, w/ 2 AVC-SFP-LX-40
8010GX2-2LX-40-PS	8010GX2, w/ 1 APS-30-24 and 2 AVC-SFP-LX-40

Technology	
<b>Standard</b>	IEEE 802.3 10Base-T Ethernet
	IEEE 802.3u 100Base-TX Fast Ethernet
	IEEE 802.3u 100Base-FX Fast Ethernet Fiber
	IEEE 802.3ab 1000Base-T Gigabit Ethernet Copper
	IEEE 802.3z Gigabit Ethernet Fiber
	IEEE 802.3x Flow Control and back-pressure
	IEEE 802.3az (Energy Efficient Ethernet)
	IEEE 802.1p Class of Service (CoS)
	IEEE 802.1Q VLAN and GVRP
	IEEE 802.1AB Link Layer Discovery Protocol (LLDP)
	IEEE 802.1D-2004 Rapid Spanning Tree Protocol (RSTP)
	IEEE 802.1S Multiple Spanning Tree Protocol (MSTP)
	IEEE 801.1AX/802.3ad Link Aggregation Control Protocol (LACP)
	IEEE 802.1x Port based Network Access Protocol
	IEEE 1588 Precision Time Protocol v2
ITU-T G.8032 version 2 Ethernet ring protection switching(ERPSv2)	
Performance	
<b>Switch Technology</b>	Store and Forward Technology with Non-Blocking Switch Fabric Internal Packet Buffer: 4Mb.Forwarding rate: 14.88Mpps/10-port (1,488,000pps/Gigabit port)
<b>CPU/RAM</b>	Cortex-A9, max. 1.2GHz, DDR3 2Gb
<b>Number of MAC Address</b>	16K
<b>Jumbo Frame</b>	9216 Bytes
<b>VLAN</b>	256 VLANs, VLAN ID 1~4094
<b>IGMP Groups</b>	512
<b>Traffic Prioritize</b>	8 Priority Queues per Port
Interface	
<b>Ethernet Port</b>	8010GX2: 8 x 100/1000Base-T RJ45, Auto Negotiation, Auto MDI/MDIX, 2 x 100/1000M SFP
<b>System LED</b>	2 x Power: Green On.1 x DO/Alarm: Red On
<b>Ethernet Port LED</b>	Link (Green On), Activity (Green Blinking), Speed 1000M(Amber On), Speed 100M (Off)
<b>SFP LED</b>	Port: Link (Green On), Activity (Green Blinking); 1000M: Speed 1000M (Amber On), Speed 100M (Off)
<b>Reset</b>	System Reboot(2-6 Seconds)/Default Settings Reset(over 7 Seconds)
<b>Console</b>	1 x RS232 in RJ45 for System Configuration. Baud Rate: 115200.n.8.1, 8010GX2: Pin Define: 3: TxD, 6:RxD, 5:GND Also available to support Pin Define: 3: RxD, 4: TxD, 6:GND (Configured by Internal Jumper)
<b>Digital Input, Digital Output</b>	4-Pin Removable Terminal Block Connector, 2-Pins for DI, 2-Pins for DO (Relay Alarm) 1x Digital Output: Dry Relay Output with 0.5A /24V DC 1x Digital Input: High: DC 11V~30V, Low: DC 0V~10V
<b>Power Input</b>	4-Pin Removable Terminal Block Connector for Redundant Power
Power Requirement	
<b>Input Voltage</b>	24VDC (12~48VDC)
<b>Reverse Polarity Protect</b>	Yes
<b>Input Current</b>	0.4A @ 24V
<b>Power Consumption</b>	Typical 9.6W@24V Max. 12W@60VDC full traffic, suggest to reserve 15% tolerance

Software	
<b>Management</b>	WebGUI, Command Line Interface (CLI), IPv4/IPv6(RFC2460), Telnet, SNMP v1/v2c/v3, RMON, SNMP Trap, LLDP, DHCP Server/Client/Option 82, TFTP, System Log, SMTP
<b>Traffic Management</b>	Flow Control, Rate Control, Storm Control, CoS, QoS, RFC 2474 DiffServ
<b>Filter</b>	IGMP Snooping v1/v2/v3, IGMP Snooping Fast-Leave/Immediate-Leave, IGMP Query, GMRP, IEEE802.1Q VLAN, QinQ, GVRP, Private VLAN
<b>Security</b>	IEEE 802.1X/RADIUS, TLS v1.2, Access Control List (ACL, MAC/IP/ARP filter), HTTPs/SSH secure login, First login password management
<b>Advanced Security</b>	Advanced Security: TACACS+, Multi-user authentication, IEEE802.1x MAB, DHCP Snooping/IPSG, Dynamic ARP inspection, SFTP
<b>Redundancy</b>	ERPSv2 Plus, ITU-T G.8032 v1/v2 Ethernet Ring Protection Switching (ERPSv2), HW CFM, Loop Protection, Rapid Spanning Tree Protocol/Spanning Tree Protocol (RSTP/STP), Multiple Spanning Tree Protocol (MSTP) eRSTP (Enhanced Rapid Spanning Tree), up to 80 switches in one Ring
<b>Time Management</b>	NTP, IEEE 1588 Precision Time Protocol v2
<b>Industrial IoT</b>	Modbus TCP
<b>Utility</b>	AIAS, ANMS (By Request)
<b>MIB</b>	ERPS MIB, MIB-II, Ethernet-like MIB*, P-BRIDGE MIB, Q-BRIDGE MIB, Bridge MIB, RMON MIB Group 1, 2, 3, 9*, Private MIB
<b>Diagnostic</b>	LLDP, Port Mirror, Ping, Port Statistic, Event Log
Mechanical	
<b>Installation</b>	DIN Rail
<b>Enclosure Material</b>	Steel Metal Additional Aluminum Side Heat Sink
<b>Dimension</b>	78 mm x155 mm x125 mm (W x H x D) / without DIN Rail Clip
<b>Ingress Protection</b>	IP41
<b>Weight</b>	~1285g without package
Environmental	
<b>Operating Temperature</b>	-40°C~75°C
<b>Humidity</b>	0%~95% Non- Condensing
<b>Storage Temperature</b>	-40°C~85°C
<b>MTBF</b>	>2,000,000 hours
<b>Warranty</b>	5 years
Standard	
<b>FCC</b>	CISPR 22, FCC part 15B Class A
<b>CE</b>	EN61000-6-2/EN61000-6-4, EN50121-4 Compliance



## Function interface

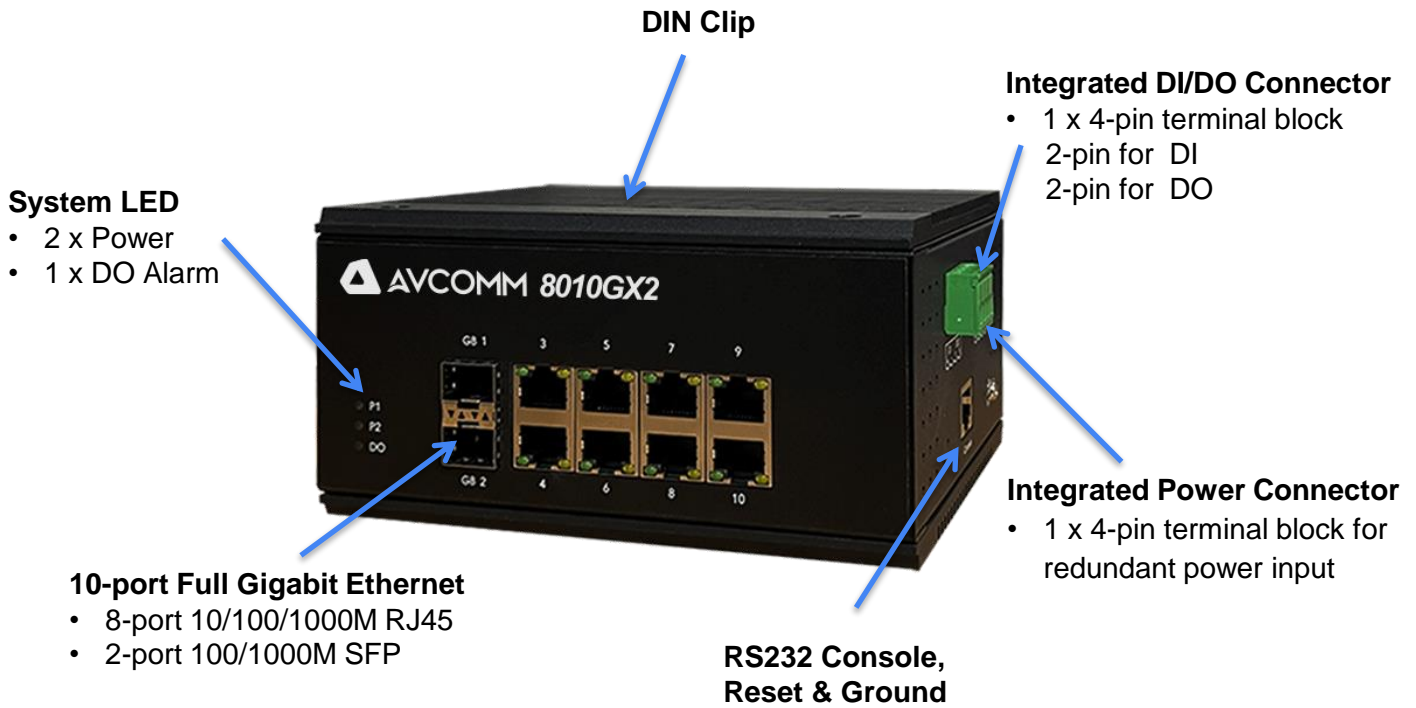

## Installation dimensions

Unit: mm

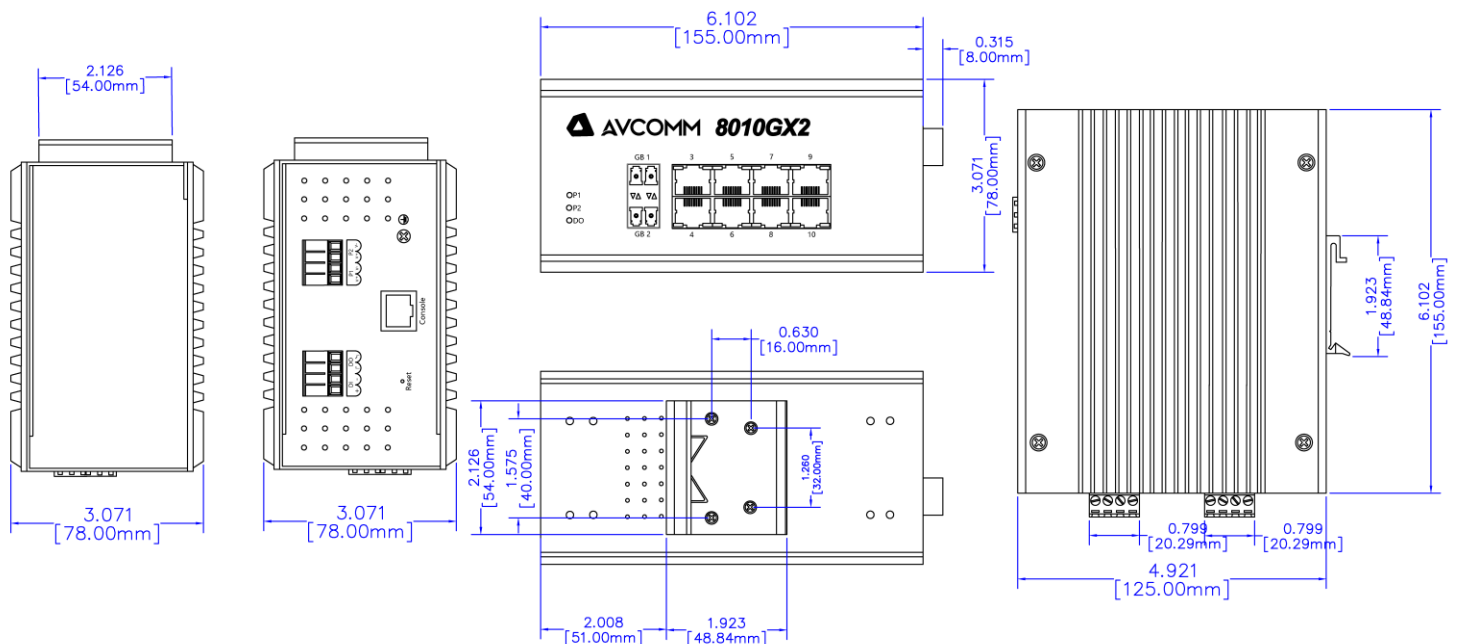

AVCOMM Technologies, Inc. All rights reserved. Trademarks and trade names that may be used in this document are owned by their respective companies. Specifications subject to change without notice. Please ask our sales for the most up-to-date product information. Avcomm Technologies Inc. Add: 333 West Loop North Ste. 460, Houston, TX 77024