



AVCOMM®

4016TX

Datasheet

Aiming to create better and safer working environments and life experiences through the products we deliver.



AVCOMM Technologies, Inc

www.avcomm.us

Email: info@avcomm.us

Phone: (713) 933-4534

Address: 333 West Loop North, Suite 460
Houston, TX 77024
United States

Reliable Plug and Play Industrial Ethernet Switch for Automation and Electrical OEM

4016TX

Industrial Unmanaged Ethernet Switch

AVCOMM 4016TX is 16-port 10/100/1000Base-TX RJ-45 unmanaged Ethernet switch with reverse polarity protection of AC or DC input. It is highly scalable and can transmit data over long distances through fiber-optic ports. It has wide operation temperature range, high anti-EMI capability to ensure stable work in harsh industrial environments and supports DIN Rail-mounted to facilitate in various industrial network applications.



Features & Benefits

Fast Ethernet Switching

- Sixteen (16) 10/100/1000BaseT(X) RJ-45 ports
- 16K MAC address table
- Store and forwarding with non-blocking technology

IEEE 802.3u EEE Power Management

- Ultra power consumption efficiency, 15 W fully loaded
- Energy Efficient Ethernet for low power requirement
- Idle power saving mode for energy efficiency

Rugged Mechanical Design

- Robust design protects from mechanical deformation
- IP40 industrial rating to withstand harsh environments
- Wide operating temperature range -40°C ~ +85°C

Power protection

- Provide overload protection
- Provide reverse connection protection
- Provide multiple power input options, AC or DC or HV



Ordering Information

Model Name	Description
4016TX	16-Port Industrial Unmanaged Ethernet Switch, 16 RJ45 10/100/1000BaseT(X), DIN-Rail, Dual Power Input 12-48VDC, -40°C to +85°C
4016TX-AC	16-Port Industrial Unmanaged Ethernet Switch, 16 RJ45 10/100/1000BaseT(X), DIN-Rail, Dual Power Input 88-264VAC, -40°C to +85°C
4016TX-HV	16-Port Industrial Unmanaged Ethernet Switch, 16 RJ45 10/100/1000BaseT(X), DIN-Rail, Dual Power Input 88-264VDC, -40°C to +85°C

 Specifications

Technology	
Standard	IEEE 802.3, IEEE 802.3u, IEEE 802.3z, IEEE 802.3ab, IEEE 802.3x
Performance	
Switch Technology	Store and Forwarding Technology with non-blocking
Number of MAC Address	16K
Packet Buffer Memory	12 MB
Backplane bandwidth	40 Gbps
Forwarding rate	1488095pps
Interface	
Ethernet Port	16 x 10/100/1000BaseT(x)RJ-45, auto-MDI/MDI-X
System LED	2 x Power: Green On ; 1 x DO Alarm: Red On ; 1 x RUN: Green On
Ethernet Port LED	Link (Green On), Active (Green Blinking)
Power Input	8-Pin Removable Terminal Connector
Power Requirement	
Input Voltage	12/24/48VDC (10~50VDC) or 110/220VAC(88~264VAC) or 110/220VDC(88~264VDC) , Redundant
Reverse Polarity Protect	Yes
Power Consumption	625mA@24V
Mechanical	
Enclosure Material	Metal
Dimension	70 mm x 150 mm x 120 mm (W x H x D) without DIN Rail Clip
Ingress Protection	IP40
Weight	1600g
Installation method	DIN Rail-mounted
Environmental	
Operating Temperature & Humidity	-40°C ~ +85°C , 0%~95% Non- Condensing
Storage Temperature	-40°C ~ +85°C
MTBF	>2,000,000 hours
Warranty	5 years
Standard	
EMI	FCC Part 15 Subpart B class A, EN55022 class A
EMS	IEC(EN)61000-4-2(ESD) IEC(EN)61000-4-3(RS) IEC(EN)61000-4-4(EFT) IEC(EN)61000-4-5(Surge) IEC(EN)61000-4-6(CS) IEC(EN)61000-4-8 IEC 60068-2-27(Shock) IEC 60068-2-32(Freefall)



Function interface

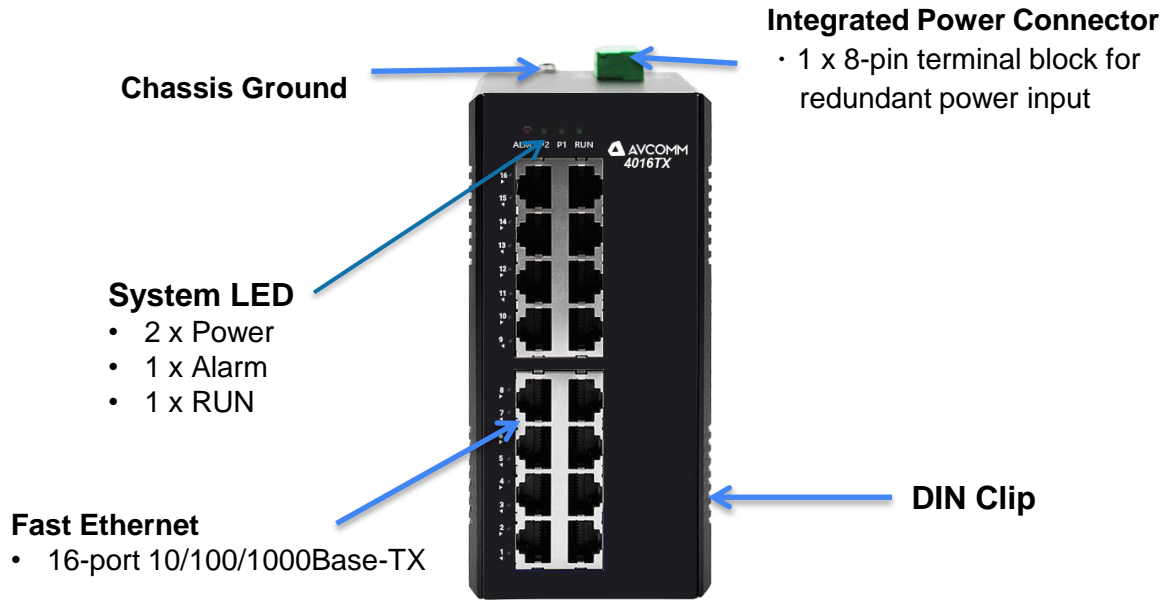

Installation dimensions

Unit: $\frac{\text{inch} \pm 0.040}{[\text{mm}] \pm 1.00}$

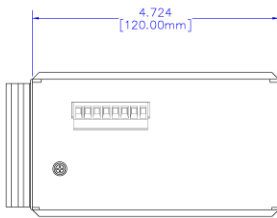

Top view

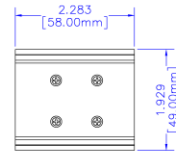

Rail piece

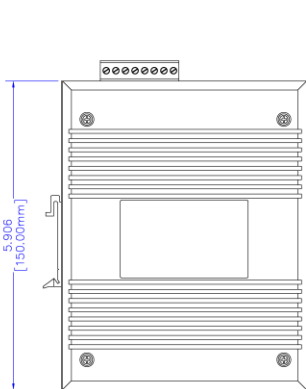

Left side view

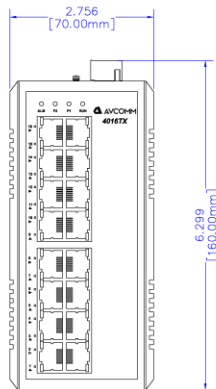

Front view

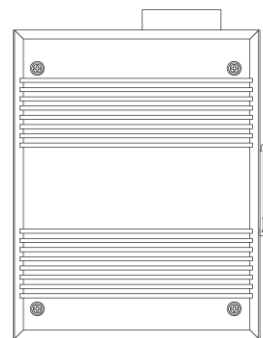

Right side view

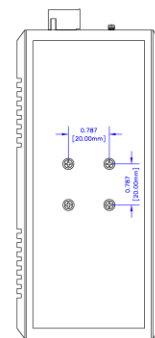

Rear view

AVCOMM Technologies, Inc. All rights reserved. Trademarks and trade names that may be used in this document are owned by their respective companies. Specifications subject to change without notice. Please ask our sales for the most up-to-date product information. Avcomm Technologies Inc. Add: 333 West Loop North Ste. 460, Houston, TX 77024