



Quick Installation Guide

8012GX2 Industrial 10G + 2GF L2+/L3 Managed Ethernet Switch

www.avcomm.us

Overview

8012GX2 is designed for industrial environments requiring high security and high-quality Ethernet/Fiber communication, such as industrial automation, road traffic control, etc. The switch provides 12-port full-gigabit Ethernet including 10-port Gigabit RJ45 and 2-port 100M/1G SFP. Full Gigabit capability and rugged industrial design ensures system high performance and reliability in harsh environments. For convenient traffic control and zero packet loss data transmission, the switch offers contemporary management and security functions.

	8012GX2
10/100/1000Base-T	10
100/1000Base SFP	2
Power input	24VDC (10~60VDC)

Package Checklist

- 1 x Product Unit (Without SFP transceiver)
- 2 x 4-pin Removable Terminal Connector
- 1 x Din Clip
- 1 x Quick Installation Guide

Optional Accessory (for detailed information please refer to the Datasheet):

- 1000Mbps SFP Transceiver
- RS232 Console Cable
- Wall-mounting kit with 2 plates and 8 screws

Installation

DIN Rail mount

To mount the switch on the DIN Rail track, insert the upper end of the DIN-Rail clip into the back of the DIN-Rail track from its upper side and lightly push the bottom of the DIN-Rail clip into the track. The DIN Rail should comply with DIN EN50022 standard. Using wrong DIN rail may cause unsafe installation.

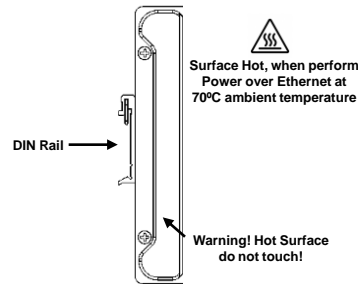

Grounding Screw

For avoiding system damage by noise or electric shock, establish a direct connection between the grounding screw and the grounding surface prior to connecting devices.

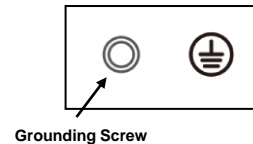

Wiring the Power Input

- 1) Insert the positive and negative wires into the V+ and V- contact on the terminal block connector.
- 2) Tighten screws when the wire is connected.
- 3) Connect the power wires to suitable DC Switching type power supply.

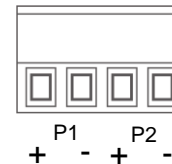

Wiring the Relay Output

The relay output of the 2-pin terminal block connector are used to detect user-configured events. The two wires attached to the fault contacts form a close circuit when a user-configured event is triggered. If a user-configured event does not occur, the fault circuit remains open.

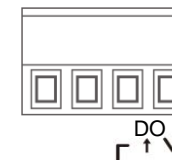

Wiring the Digital Input

To wire the DI on the Terminal block, loosen screws by screwdriver on the terminal block connector, insert the positive and negative wires into the V+ and V- contact and then tighten screws after the DI wire is connected.

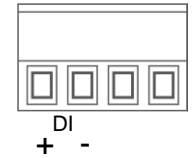

Console/Reset Port

The switch provide Reset and RS232 console for out of band configuration. The default baud rate setting is 115,200, N, 8, 1. Reset button allows you to reset switch or reload to factory default (>7 sec).

For further configurations, please refer to User Manual.

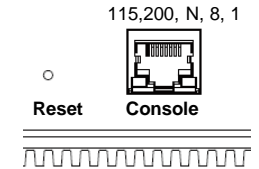

Baud Rate: 115200 / Parity: None / Data Bit: 8 / Stop Bit: 1

Appearance

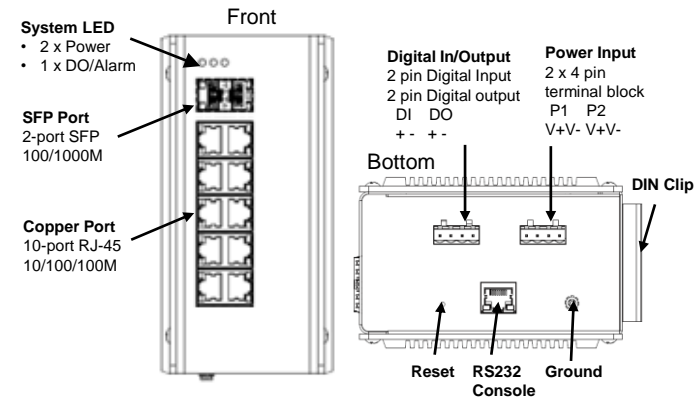

System LED Indication

LED	Status	Description
PWR (P1/P2)	Green On	DC-IN Power is On
	Off	No Power in DC-IN
Alarm (DO)	Red On	Any failures in port link, ping, power, DO and DI State by SW control
	Off	No failure occurs

• Port LED Indication

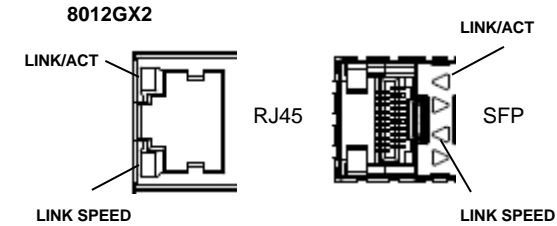

LED	Status	Description
RJ45 Port	Green On	Links established
	Green Blinking	Packets transmitting/receiving
	Green Off	Link is inactive
	Amber On	Link Speed 1000M
	Amber Off	Link Speed 100M
SFP Port	Green On	Links established
	Green Blinking	Packets transmitting/receiving
	Green Off	Link is inactive
	Amber On	Link Speed 1000M
	Amber Off	Link Speed 100M

• Safety Precautions

- Keep DC power off before connecting to the terminal block connectors and ensure all connections are secure established.
- Do make sure that models connect to the corresponding supply voltage. The device is to be supplied by Limited Power Supply. The relay contact supports 0.5 A current, DC 24V.
- The DIN Rail should comply with DIN EN50022 standard. Using wrong DIN rail may cause unsafe installation.
- **Do not touch the surface of the switch while it is performing in the high temperature environment!**

• Management

This device supports both in-band and out-of-band network management. The user can either configure the device through the user-friendly Web/HTTPS management or remotely manage the device through the network by console management or Telnet/SSH.

1. **Web management:** Before start, confirm that device is properly connected in the network and that each PC in this network can access the router through the web browser (Google Chrome, Internet Explorer, Mozilla Firefox).
 - Type `http://IP_address` in the address bar (Default IP address is <http://192.168.10.1/>)
 - Enter the username and password in Login screen and click Login. The default username and password are **admin**.
 - You are required to change your password at first login. the welcome page of the web-based management interface will pop up when password is changed.
 - On the left side listed software features, and on the right side are available settings.
- ◆ To link with the device, please make sure that the IP Address of the PC is located in the same subnet (**192.168.10.x**).
2. **Console management (using RS232 Port):**
 - Connect console cable between your PC and the device.
 - Start -> Program -> Accessories -> Communication -> Hyper Terminal.
 - Give a name to a new console connection.
 - Choose the COM name and select correct serial settings: Baud Rate: 115200 / Parity: None / Data Bit: 8 / Stop Bit: 1
 - After connected, Key in the **New** user name and password in login screen while first Login. (The default user name and password in elder firmware is *admin/admin*. Try this while you don't see New user name/password prompt while first login.)
 - Follow the User Manual to configure the software features.
3. **Telnet/SSH management.** The router can be connected by Telnet and the command-lines. Steps to open Telnet connection to the router are as follow:
 - Start -> Open Command prompt ->Enter
 - Type the Telnet `192.168.10.1` (or the IP address of the switch). And then press Enter.

SSH (Secure Shell)

The router supports SSH console and can be connected via command-line interface access remotely. SSH connection can secure all the configuration commands that sent to the switch.

SSH Client

There are many free, sharewares, trials or charged SSH clients you can find on the internet.

- ◆ **For further feature configurations, please refer to User Manual.**

• Support

At AVCOMM, you can use the online service forms to **request the support**. The submitted forms are stored in server for AVCOMM team member to assign tasks and monitor the status of your service. Please feel free to write to info@avcomm.us if you encounter any problems.

• Warranty

5-year Global warranty are available for AVCOMM products assuring our customers that the products shall remain free from defects in workmanship or materials and conform in all material respects to AVCOMM specifications, or purchasers supplied and accepted specifications. The warranty is limited to the repair and/or replacement, at AVCOMM sole discretion, of the defective product during its warranty period. The customer must obtain a Return Merchandise Authorization (RMA) approval code prior to returning the defective Product to AVCOMM for service. The customer agrees to prepay shipping charges, to use the original shipping package or equivalent, and to ensure the product or assume the risk of loss or damage in transit. repaired or replaced products are warranted for ninety (90) days from the date of repair or replacement, or for the remainder of the original product's warranty period, whichever is longer.

• Disclaimer

AVCOMM reserves the right to make changes to this QIG or to the product hardware at any time without notice. It is the user's responsibility to determine whether there have been any such updates or amendments herein.

Defects, malfunctions, or failures of the warranted Product(s) caused by damage resulting from unforeseeable incidents (such as lightings, floods, fire, etc.), environmental and atmospheric disturbances, other external forces such as power line disturbances and surge, host computer malfunction and virus, incorrect power input, or incorrect cabling, incorrect grounding and damages caused by misuse, abuse and unauthorized alteration or repair are not warranted.