



## Quick Installation Guide

### 8008GX2-PN Industrial 8G L2+ Managed Ethernet Switch

www.avcomm.us

#### • Overview

8008GX2 provides 8-port PROFINET I/O Profile gigabit Ethernet including 6-port 10/100/1000 BaseT(X) RJ45 and 2-port 100/1000 BaseSFP. 8008GX2-PN offer PROFINET I/O functionality that can be integrated into STEP 7 management tool. 8008GX2-PN is full Gigabit Ethernet switch, providing 8 Gigabit ports for upgrading the existing network infrastructure to full gigabit speed. With the powerful features, 8008GX2-PN is easily to prioritize, partition and organize user's network and provide reliable and quality services that fit perfectly into factory automation applications.

	8008GX2-PN
10/100/1000Base-T	6
100/1000 BaseSFP	2
Power input	12-58 VDC

#### • Package Checklist

- 1 x Product Unit (Without SFP transceiver)
- 1x 4-pin Removable Terminal Connector
- 1 x Din Clip
- 1 x Quick Installation Guide

Optional Accessory (Please refer to the Datasheet for details):

- RS232 Console Cable
- Wall-mounting kit with 2 plates and 8 screws

#### • Installation

##### DIN Rail mount

To mount the switch on the DIN Rail track, insert the upper end of the DIN-Rail clip into the back of the DIN-Rail track from its upper side and lightly push the bottom of the DIN-Rail clip into the track. The DIN Rail should comply with DIN EN50022 standard. Using wrong DIN rail may cause unsafe installation.

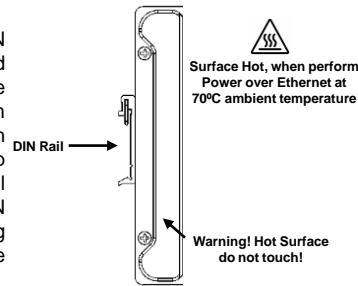

##### Grounding Screw

For avoiding system damage by noise or electric shock, establish a direct connection between the grounding screw and the grounding surface prior to connecting devices.

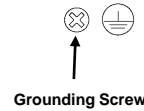

##### Wiring the Power Input

- 1) Insert the positive and negative wires into the V+ and V- contact on the terminal block connector.
- 2) Tighten screws when the wire is connected.
- 3) Connect the power wires to suitable DC Switching type power supply.

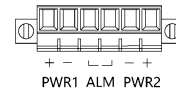

##### Alarm Relay

The alarm relay output contacts are in the middle of the DC terminal block connector. The alarm relay out is "Normal Open", and it will be closed when detected any predefined failure such as power failures or Ethernet link failures. The relay output with current carrying capacity of 0.5A @ 24 VDC

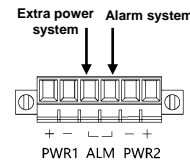

#### Console/Reset Port

The switch provide Reset and RS232 console for out of band configuration. The default baud rate setting is 115,200, N, 8, 1. Reset button allows you to reset switch or reload to factory default (>7 sec).

For further configurations, please refer to User Manual.

115,200, N, 8, 1

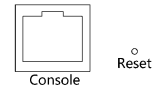

Baud Rate: 115200 /  
Parity: None / Data Bit: 8 / Stop Bit: 1

#### • Appearance

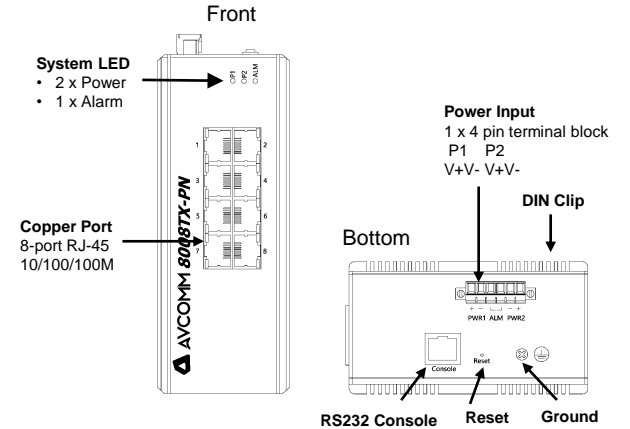

#### • LED Indication

LED	Status	Description
PWR (P1/P2)	On Green	P1/P2 power line has power
	Off	P1/P2 power line disconnect or does not have power supplied
Alarm	On Red	Ethernet link fails, alarm or power failure alarm occurs
	Off	No Ethernet link fails and no power failure alarm
Copper port Link/Act	On Green	Ethernet link up but no traffic is detected
	Flashing Green	Ethernet link up and there is traffic detected
	Off	Ethernet link down
Copper port Speed	On Amber	A 1000Mbps connection is detected
	Off	No link, a 10Mbps or 100 Mbps connection is detected
SFP port Link/Act	On Green	Ethernet link up
	Off	Ethernet link down

SFP port Speed	On Amber	SFP port speed 1000Mbps connection is detected.
	Off	No link or a SFP port speed 100Mbps connection is detected

### • Ethernet Interface

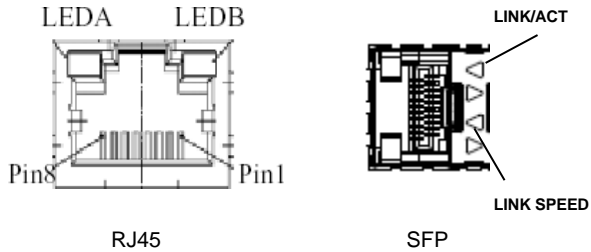

Pin	Assignment
1,2	T/Rx+, T/Rx-
3,6	T/Rx+, T/Rx-
4,5	T/Rx+, T/Rx-
7,8	T/Rx+, T/Rx-

### • Safety Precautions

- Keep DC power off before connecting to the terminal block connectors and ensure all connections are secure established.
- Do make sure that models connect to the corresponding supply voltage. The device is to be supplied by Limited Power Supply. The relay contact supports 0.5 A current, DC 24V.
- The DIN Rail should comply with DIN EN50022 standard. Using wrong DIN rail may cause unsafe installation.
- **Do not touch the surface of the switch while it is performing in the high temperature environment!**

### • Management

- Connect & Login to Managed Switch
  1. Connecting to the Ethernet port (RJ45 Ethernet port) of Managed Switch.
  2. Factory default IP: 192.0.2.1
  3. Login with default account and password.
    - Username: admin
    - Password: (none)
- CLI Initialization & Configuration (Optional)
  1. Connecting to the Ethernet port(RJ45 Ethernet port) of Managed Switch
  2. Key-in the command under Telnet: telnet 192.0.2.1
  3. Login with default account and password.
    - Username: admin
    - Password: (none)
  4. Change the IP with commands listed below:  
CLI Command:

```
enable
configure terminal interface vlan 1
ip address xxx.xxx.xxx.xxx xxx.xxx.xxx.xxx
exit
```

◆ **For further feature configurations, please refer to User Manual.**

### • Support

At AVCOMM, you can use the online service forms to **request the support**. The submitted forms are stored in server for AVCOMM team member to assign tasks and monitor the status of your service. Please feel free to write to [info@avcomm.us](mailto:info@avcomm.us) if you encounter any problems.

### • Warranty

**5-year Global warranty** are available for AVCOMM products assuring our customers that the products shall remain free from defects in workmanship or materials and conform in all material respects to AVCOMM specifications, or purchasers supplied and accepted specifications. The warranty is limited to the repair and/or replacement, at AVCOMM sole discretion, of the defective product during its warranty period. The customer must obtain a Return Merchandise Authorization (RMA) approval code prior to returning the defective Product to AVCOMM for service. The customer agrees to prepay shipping charges, to use the original shipping package or equivalent, and to ensure the product or assume the risk of loss or damage in transit. repaired or replaced products are warranted for ninety (90) days from the date of repair or replacement, or for the remainder of the original product's warranty period, whichever is longer.

### • Disclaimer

AVCOMM reserves the right to make changes to this QIG or to the product hardware at any time without notice. It is the user's responsibility to determine whether there have been any such updates or amendments herein.

Defects, malfunctions, or failures of the warranted Product(s) caused by damage resulting from unforeseeable incidents (such as lightings, floods, fire, etc.), environmental and atmospheric disturbances, other external forces such as power line disturbances and surge, host computer malfunction and virus, incorrect power input, or incorrect cabling, incorrect grounding and damages caused by misuse, abuse and unauthorized alteration or repair are not warranted.